

MEMS, Field-Emitter, Thermal, Fluidic Devices, and Robotics

Langmuir Probes via Rapid Prototyping for CubeSat and Laboratory Plasma Diagnostics.....	72
Compact, Digitally Manufactured Retarding Potential Analyzers Enabled for CubeSat and Laboratory Plasma Diagnostics.....	73
FFF 3D-Printed Inductors for PowerMEMS	74
Inverse Design of Flexible Tactile Sensor	75
Macroscopic Trampoline for Precision Force Sensing.....	76
Knowledge Management System for MEMS Incorporating Heterogeneous Data Sources	77
Nanowire-Coated Emitter Electrospray Ionizer Coupled to Digital Microfluidics for Liquid Analysis.....	78
Internally Fed, Additively Manufactured Electrospray Thrusters for CubeSats	79
FireFly: An Insect-scale Aerial Robot Powered by Electroluminescent Soft Artificial Muscles.....	80
Soft Material Design of Additively Manufactured Actuators to Control Stress Distribution.....	81
Improving Reliability and Performance of Microhydraulic Electrowetting Actuators	82
3D-Printed Reflectron for Compact Mass Spectrometry	83
MEMS Digitalized Igniter or Primer for Solid Propellant Grains and Two-spool Micro Gas Turbine Engine Concept.....	84
Advanced Electromembrane Process for Portable Desalination Unit.....	85

Langmuir Probes via Rapid Prototyping for CubeSat and Laboratory Plasma Diagnostics

Z. Bigelow, L. F. Velásquez-García
Sponsorship: MIT Portugal

Langmuir probes (LPs) are widely considered to be the most versatile in-situ plasma sensors due to the simplicity of their design, small cross section, low maintenance requirements, and compatibility with a very broad range of plasma conditions. When operated with compact, low-power electronics, LPs can be installed onboard CubeSats to characterize the space environment surrounding the spacecraft. Moreover, miniaturized LPs can be used to make local plasma measurements. Basic LPs have a single electrode that collects a current while sweeping a bias voltage; from the current-voltage characteristic, plasma parameters such as the electron temperature and number density can be extracted. LPs can also be operated in groups to improve the measurements: for example, double LPs are less sensitive to plasma fluctuations as they are energized by a floating bias voltage. Also, triple LPs conduct faster measurements because they do not need to sweep any voltages during measurement. However, in

a multi-probe LP, care must be taken to spatially spread out the probes to avoid cross-talking.

This project focuses on designing, fabricating, and characterizing compact single, double, and triple LPs with integrated, custom electronics (Figure 1) for CubeSat and laboratory plasma applications. The probes will be manufactured via rapid prototyping, exploring the limits of the technology to implement sensors compatible with the coldest, densest plasmas possible, as well as the ionosphere. The circuitry is being designed to enable low-power, autonomous operation. To fabricate the probes, we plan to use metal 3D printing (Figure 2), laser cutting, and plating for creating the electrically conductive parts of the probes and ceramic 3D printing for the dielectric parts of the probe and housing of the electronics. Current research focuses on completing the hardware design, which will be followed by device/driving electronics manufacture and characterization.

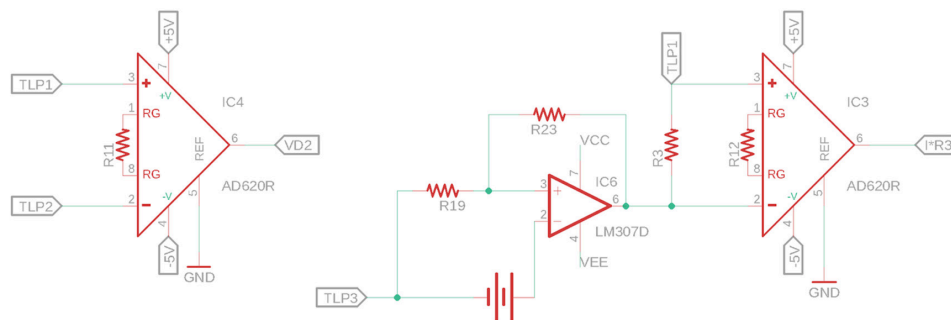

▲ Figure 1: Integrated circuit design for triple LP.



▲ Figure 2: CAD of a 3D-printed, single LP electrode.

FURTHER READING

- L. F. Velásquez-García, J. Izquierdo-Reyes, and H. Kim, "Review of In-Space Plasma Diagnostics for Studying the Earth's Ionosphere," *Journal of Physics D: Applied Physics*, vol. 55, no. 26, p. 263001, 2022
- E. V. Heubel and L. F. Velásquez-García, "Microfabricated Retarding Potential Analyzers with Enforced Aperture Alignment for Improved Ion Energy Measurements in Plasmas," *Journal of Microelectromechanical Systems*, vol. 24, no. 5, pp. 1355-1369, Oct. 2015.
- E. F. C. Chimamkpa, E. S. Field, A. I. Akinwande, and L. F. Velásquez-García, "Resilient Batch-Fabricated Planar Arrays of Miniaturized Langmuir Probes for Real-Time Measurement of Plasma Potential Fluctuations in the HF to Microwave Frequency Range," *Journal of Microelectromechanical Systems*, vol. 23, no. 5, pp. 1131-1140, Oct. 2014.

Compact, Digitally Manufactured Retarding Potential Analyzers Enabled for CubeSat and Laboratory Plasma Diagnostics

J. Izquierdo-Reyes, Z. Bigelow, N. K. Lubinsky, L. F. Velásquez-García
Sponsorship: MIT Portugal, MIT-Tecnologico de Monterrey Nanotechnology Program

Retarding potential analyzers (RPAs) are multi-gridded sensors that determine a plasma's ion energy distribution (Figure 1). In this project, we are developing novel, digitally manufactured RPAs for CubeSat and laboratory plasma diagnostics. Unlike most RPAs reported in the literature, our devices enforce aperture alignment across the grid stack, maximizing ion transmission. The core of the device is a set of laser-cut electrodes assembled into a 3-D printed Vitrolite® (a glass ceramic) housing (Figure 2). Characterization of the Vitrolite® printing process shows an in-plane, per axis manufacturing accuracy of 60 μm for the as-printed (green) parts and a ~5% shrinkage for the parts annealed at 900 °C; higher

annealing temperatures cause significant distortion of the printed part due to material reflow, which is problematic for an engineering application. Also, the assembly misalignment between the grids and the housing significantly worsens when using a housing annealed at 900 °C. Characterization of the devices via simulations and experiments is consistent with expected performance and the literature. Plasmas with a Debye length as small as 50 μm have been successfully characterized using the reported sensors, matching the performance of state-of-the-art RPAs manufactured via semiconductor micro-fabrication.

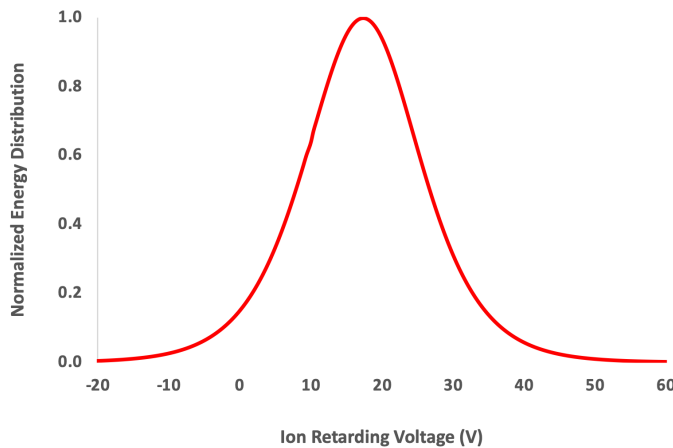

◀ Figure 1: Plasma ion energy distribution measured with a digitally manufactured RPA.

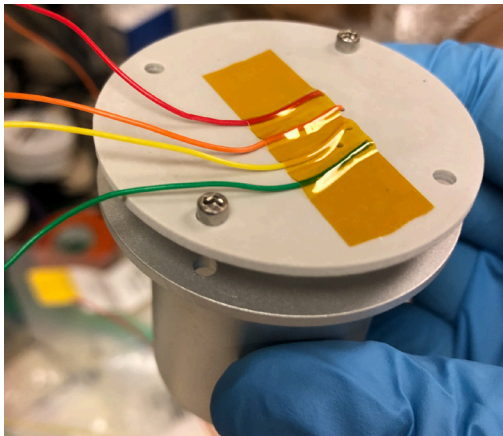

◀ Figure 2: A partially assembled retarding potential analyzer.

FURTHER READING

- E. V. Heubel and L. F. Velásquez-García, "Microfabricated Retarding Potential Analyzers with Enforced Aperture Alignment for Improved Ion Energy Measurements in Plasmas," *J. Microelectromech Syst.*, vol. 24, no. 5, pp.1355-1369, 2015.
- L. F. Velásquez-García, J. Izquierdo-Reyes, and H. Kim, "Review of In-Space Plasma Diagnostics for Studying the Earth's Ionosphere," *Journal of Physics D: Applied Physics*, vol. 55, no. 26, p. 263001, 2022.
- Z. Sun, G. Vladimirov, E. Nikolaev, and L. F. Velásquez-García, "Exploration of Metal 3-D Printing Technologies for the Microfabrication of Freeform, Finely Featured, Mesoscaled Structures," *Journal of Microelectromechanical Systems*, vol. 27, pp. 1171-1185, 2018.

FFF 3D-Printed Inductors for PowerMEMS

J. Cañada, L. F. Velásquez-García
Sponsorship: Empiriko Corporation

Magnetic actuators are among the most essential building blocks of electromechanical systems. In this project, we are exploring ways to manufacture electromagnetic actuators with commodity 3D printers. The 3D printing of electromagnetic actuators can enable fast and inexpensive prototyping and customization in fields like PowerMEMS and robotics, including soft robotics.

Fused filament fabrication (FFF) is a 3D printing method in which a thermoplastic-based material is extruded through a nozzle and deposited layer by layer to construct solid parts. FFF printers equipped with multiple nozzles allow the simultaneous use of several materials, which facilitates the monolithic fabrication of multi-material parts. By using such printers, we intend to monolithically print electromagnetic actuators consisting of permanent magnets, electrically conductive inductors, and rigid or flexible frames.

The 3D printing of magnets has already been demonstrated in previous work, and we are currently

working on printing inductors using a copper nanoparticle-doped thermoplastic. The resistivity of this material is three orders of magnitude above that of copper, which raises the challenge of generating useful magnetic fields with only moderately conductive material. A spiral printed with this material is shown in Figure 1.

Figure 2 shows an estimate of the magnetic fields that an inductor built up of stacked spirals like the one shown in Figure 1 can generate. This estimation was computed under two restrictions: (i) the current through the inductor can never exceed the maximum current recommended by the material manufacturer, and (ii) the voltage applied across the inductor cannot exceed 200 V. The results indicate that the maximum achievable magnetic field is on the order of a few Gauss. Upcoming work will explore ways to boost these magnetic fields by adding magnetic cores to the printed inductors.

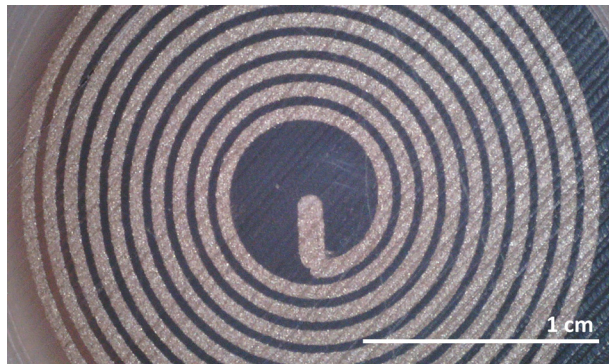

▲ Figure 1: Spiral printed using copper-doped thermoplastic.

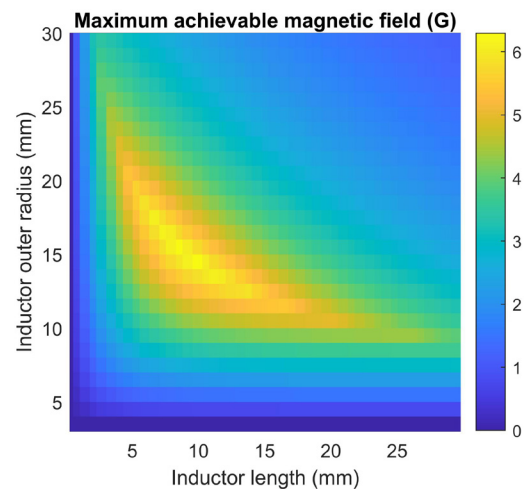

▲ Figure 2: Estimate of maximum achievable magnetic field as a function of inductor size. Outer radius translates to the number of loops in a spiral; length translates to the number of stacked spirals.

FURTHER READING

- A. P. Taylor, C. Vélez Cuervo, D. P. Arnold, L. F. Velásquez-García, "Fully 3D-printed, Monolithic, Mini Magnetic Actuators for Low-cost, Compact Systems," *Journal of Microelectromechanical Systems*, vol. 28, no. 3, pp. 481-493, June 2019, doi: 10.1109/JMEMS.2019.2910215.
- A. P. Taylor, J. Izquierdo-Reyes, L. F. Velásquez-García, "Compact, Magnetically Actuated, Additively Manufactured Pumps for Liquids and Gases," *J. Phys. D: Appl. Phys.*, vol. 53, p. 355002, 2020.
- A. P. Taylor and L. F. Velásquez-García, "Miniaturized Diaphragm Vacuum Pump by Multi-material Additive Manufacturing," *J. Microelectromech. Sys.* vol. 26, no. 6, pp. 1316-1326, Dec. 2017.

Inverse Design of Flexible Tactile Sensor

Z. Liu, M. Cai, S. Hong, J. Shi, S. Xie, G. Li, J. D. Morin, N. Fang, C. Guo
Sponsorship: Southern University of Science and Technology

Tactile sensors with customized performance are desirable for various sensing scenarios. In the case of flexible pressure sensors, designs are mainly empirical and not target-oriented, leading to low efficiency and high cost due to the inevitable long-term trial-and-error. In this project, we explore novel inverse design methodology for dealing with the intractable high-cost problem. With this method, performance targets consist of multiple indicators (sensitivity, sensing range, linearity, etc.) are comprehensively investigated by a machine learning (ML) algorithm, and a hybrid data collection

approach is adopted to efficiently shorten the number of iterations. The designs suggested by a well-trained ML model can solve the universal response-saturation problem in a flexible tactile sensor, and further achieve a broad sensing range with steady sensitivity. The finalized configuration can be widely applied to many other material systems. Our proposed configuration and the inverse design methodology build the bridge between mechanical geometries and electrical signals, which is promising to modulate multiple performance indicators and different sensing mechanisms.

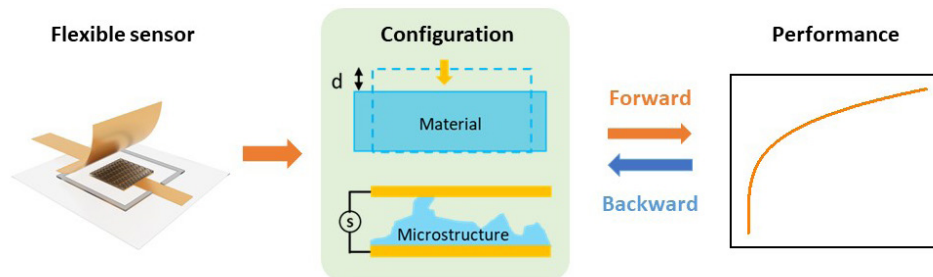

▲ Figure 1: Schematic of forward and inverse design in flexible tactile sensor.

FURTHER READING

- P. Zhu, H. Du, X. Hou, P. Lu, L. Wang, J. Huang, N. Bai, Z. Wu, N. Fang, and C. Guo, "Skin-electrode Iontronic Interface for Mechanosensing," *Nature Communications*, vol. 12, p. 4731, 2021.

Macroscopic Trampoline for Precision Force Sensing

D. S. Fife, V. Sudhir

Silicon nitride nano-trampoline resonators have become established as a platform for low-noise force sensing and optomechanics. These resonators are constructed by patterning a silicon nitride membrane with a central pad suspended by tethers (see Figure 1). Here, a milligram-scale mirror is bonded to the trampoline to couple this resonator with a gravitational potential. Our aim is to perform precision gravity measurements with milligram-scale masses and eventually observe the effect of gravity on massive quantum states.

Macroscopic mechanical oscillators appear to exhibit classical behavior due to the difficulty of isolating them from the ubiquitous thermal

environment. However, their thermal noise can be decreased by increasing the quality factor (Q). There are two primary methods being applied to increase Q , dissipation dilution, and phononic bandgap engineering. Dissipation dilution is a phenomenon whereby an external lossless potential is applied to a resonator to stiffen it and reduce energy in lossy modes. The potentials that will be used are the internal stress of the membrane and the radiation pressure from an optical cavity. By engineering phononic crystals into the tether, we confine the phonons compromising the mode to the center of the resonator. This prevents the loss of energy through the clamps to the frame.

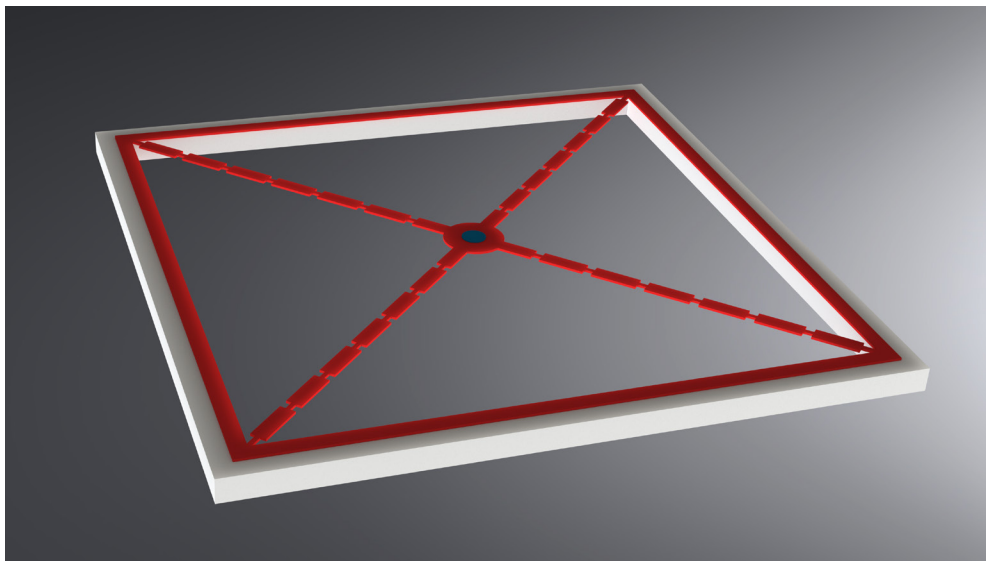

▲ Figure 1: Not-to-scale diagram of a trampoline resonator. Red: silicon nitride. Gray: silicon substrate. Blue: gadolinium gallium garnet mirror.

Knowledge Management System for MEMS Incorporating Heterogeneous Data Sources

J. Gammack, H. Akay, S.-G. Kim
Sponsorship: NSF LEAP-HI

Research at MIT's Microsystems Technology Laboratories (MTL) and micro/nano focused conferences such as Hilton Head Workshop has resulted in decades of micro- and nano-technology innovation. The total information from these contributions is valuable institutional knowledge and is documented meticulously by researchers in the form of theses, published papers, posters, and a wide range of textual and graphical design and process data. Due to the huge scale of this data and the distributed nature of its storage, it can be challenging for newcomers to learn from past achievements of the community. We aim to enable the availability and accessibility of this big data by developing a semantically searchable knowledge management system, so researchers can expedite the process of learning from past design successes and failures.

We applied artificial intelligence-based natural language processing (NLP) models, fine-tuned on technical microsystems research documents, to

represent the semantic meaning contained within the text of theses, research papers, and process documents in order to construct a knowledge base from which information can be easily retrieved. By encoding language descriptions of functional information and graphical figures via their captions and referencing sentences, we can represent semantic knowledge from heterogeneous documents to structure and distill vast repositories of unstructured documentation (Figure 1). We developed an interactive question-answering system where users retrieve answers to questions as well as relevant data (Figure 2). Currently, we have encoded 16 years of MTL report abstracts, 4,800 theses, and Hilton Head Transducers Technical Digests from 1984-2021. In the future, this system will be further generalized to extract micro-/nano-specific design knowledge, process sequences, and material choices into an ever-growing knowledge base to benefit MTL researchers.

▶ Figure 1: Creation of associative micro/nano knowledge base by automatically crawling MTL reports, theses, and Hilton Head Workshop submissions. To find answers to user queries, we compared queries and encoded sentences in the knowledge base.

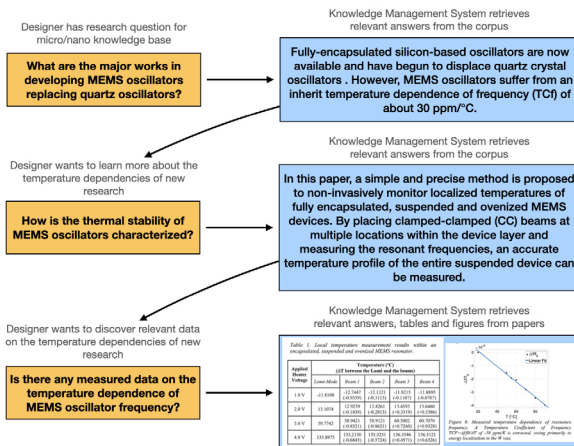
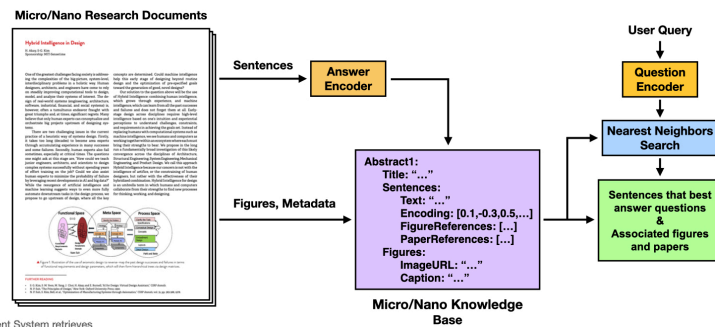

◀ Figure 2: Case study of knowledge retrieval from decades of micro/nano-related research. Answers to questions may be direct textual answers or may include relevant graphical or tabular data that is referenced.

FURTHER READING

- J. Gammack, H. Akay, and S.-G. Kim, "Semantic Knowledge Management System for Design Documentation with Heterogeneous Data Using Machine Learning," *Procedia CIRP*, in press, 2022.
- H. Akay and S.-G. Kim, "Reading Functional Requirements Using Machine Learning-based Language Processing," *CIRP Annals*, vol. 70, no. 1, pp. 139-142, 2021.
- H. Akay, M. Yang, and S.-G. Kim, "Automating Design Requirement Extraction from Text with Deep Learning," *ASME IDETC-CIE Proceedings*, Online, 2021.

Nanowire-Coated Emitter Electro spray Ionizer Coupled to Digital Microfluidics for Liquid Analysis

A. Kachkine, L. F. Velásquez-García
Sponsorship: Empiriko Corporation

Liquid sample processing for mass spectrometry involves the extraction of a target analyte, addition of solvents, and ionization. Solid-state, programmable digital microfluidics have emerged as versatile platforms for sample manipulation, while ionization can be efficiently conducted via electrospray, i.e., the emission of charged molecules from a liquid subjected to a high electric field. Our group previously developed nanowire-coated emitters, which have pure ion emission and are thus of interest to mass spectrometry due to potential noise reduction. We present the first integration of high-efficiency nanowire-coated emitters and digital microfluidics: a single device for sample manipulation and ambient electrospray (Figure 1).

Device fabrication takes ~7 hours and costs ~\$5 in materials, with preparation of the digital microfluidic components taking under 10 minutes at a cost of ~\$1 with no cleanroom processing. The emitter is made out of steel via binder jetting, and then undergoes electropolishing, seed layer deposition, and zinc oxide

nanowire growth in a hydrothermal bath. Digital microfluidic components comprise commercially-fabricated printed circuit boards, laser cut plastics, drop-cast Teflon layers, and a polymeric casing made via digital light processing.

Sample droplets are moved through the device and onto the emitter via a paper conduit. Under comparatively low emitter extraction voltages (2-2.5 kV) our device has two-fold greater electrospray currents than state-of-the-art methods used with digital microfluidics (Figure 2). The electrospray dynamics are time-variant: an initial unstable, short-duration Taylor cone is followed by a secondary, stable electrospray without a visible plume, lasting about 20 seconds while using 5 μ L of solvent. Ongoing work focuses on characterizing devices interfaced with a mass spectrometer, improving device reliability, and fully characterizing electrospray dynamics. Images are from the first further reading publication below.

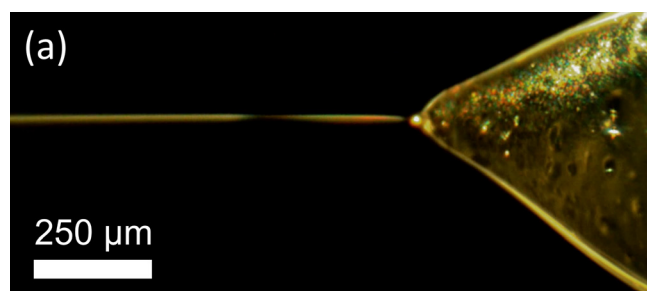

◀ Figure 1: (a) Fabricated device with receptor used for externally actuating device functions and (b) labeled exploded view of device, showing key internal components.

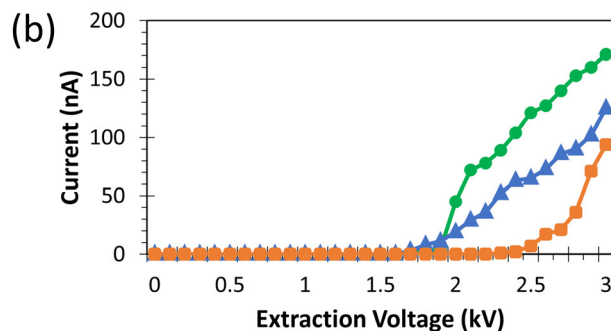

◀ Figure 2: (b) Electrospray of isopropanol from nanowire-coated emitter (device casing removed) and (b) plot of average current versus voltage for nanowire-coated emitter (circles), paper emitter (triangles), and coated blade (squares) with isopropanol as solvent.

FURTHER READING

- A. Kachkine and L. F. Velásquez-García, "Nanowire-Coated Emitter Electro spray Ionizer Coupled to Digital Microfluidics for Liquid Analysis," *Proceedings of the IEEE 35th International Conference on Micro Electro Mechanical Systems*, pp. 95-98, 2022.
- D. V. M. Máximo and L. F. Velásquez-García, "Additively Manufactured Electrohydrodynamic Ionic Liquid Pure-ion Sources for Nanosatellite Propulsion," *Additive Manufacturing*, vol. 36, p. 101719, Dec. 2020.
- F. A. Hill, E. V. Heubel, P. J. Ponce de Leon, and L. F. Velásquez-García, "High-throughput Ionic Liquid Ion Sources Using Arrays of Microfabricated Electro spray Emitters with Integrated Extractor Grid and Carbon Nanotube Flow Control Structures," *Journal of Microelectromechanical Systems*, vol. 23, pp. 1237-1248, Oct. 2014.

Internally Fed, Additively Manufactured Electro spray Thrusters for CubeSats

H. Kim, L. F. Velásquez-García
Sponsorship: MIT Portugal

Electrospray engines have one or more emitters that electrohydrodynamically eject high-speed charged particles from liquids to produce thrust. Stable electro-spray emission, which can be used in a propulsion application, exists for a limited range of electric fields and flow rates. Whether the thruster emits ions or droplets is determined by the flow rate of the propellant. On the one hand, if the flow rate is below a certain threshold value, the engine emits ions, exerting a high-specific impulse, low force to the spacecraft. On the other hand, if the flow rate is above the threshold value, the engine emits droplets, creating a larger thrust with lower specific impulse. In principle, both kinds of emission are useful for propelling a spacecraft.

The electric field strength needed to activate the electro spray emitters is proportional to the square root of the emitter diameter; therefore, electro spray thrusters benefit from miniaturization, as scaled-down emitters turn-on with less voltage. Miniaturization of electro spray engines has traditionally been accomplished using semiconductor

fabrication. However, this manufacturing approach is expensive and time-consuming. Therefore, fabrication approaches that can create complex hardware at a low cost and manufacturing time would greatly help lower the cost of space hardware including CubeSats.

In this project, we are exploring additive manufacturing via digital light processing to create CubeSat electro spray thrusters. We are currently focusing on developing electro spray engines that emit droplets. Before testing multiplexed designs, we are first investigating a single-emitter design to check the essential parameters for electro spray (Figure 1). The high electric field acting on the electro spray emitters is affected by the bias voltage between the propellant and the electrode that extracts droplets, as well as the separation distance between the emitter and the extractor electrode. Therefore, the design needs to be optimized to minimize the start-up voltage. In addition, the upper limit for the flow rate to sustain stable droplet emission needs to be characterized.

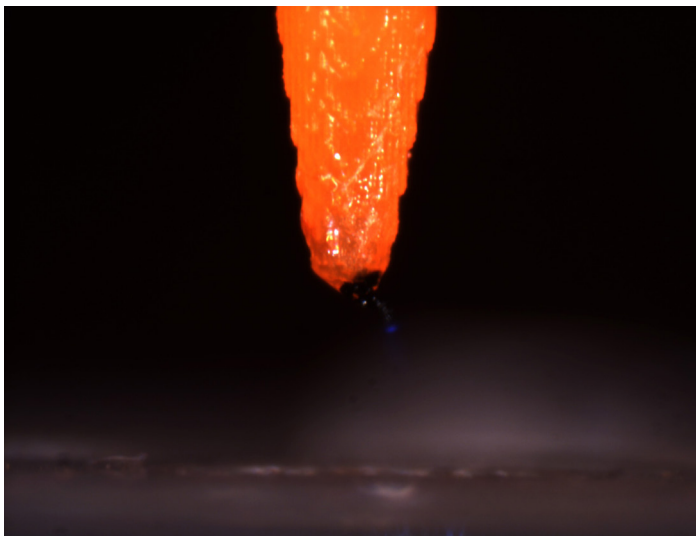

◀ Figure 1: The Taylor cone generated on the additively manufactured emitter.

FURTHER READING

- D. Olvera-Trejo and L. F. Velásquez-García, "Additively Manufactured MEMS Multiplexed Coaxial Electro spray Sources for High-Throughput, Uniform Generation of Core-Shell Microparticles," *Lab on a Chip*, vol. 16, no. 21, pp. 4121-4132, Oct. 2016.
- D. V. Melo Maximo and L. F. Velásquez-García, "Additively Manufactured Electrohydrodynamic Ionic Liquid Pure-Ion Sources for Nanosatellite Propulsion," *Additive Manufacturing*, vol. 36, p. 101719, Dec. 2020.
- E. García-López, D. Olvera-Trejo, and L. F. Velásquez-García, "3-D Printed Multiplexed Electrospinning Sources for Large-Scale Production of Aligned Nanofiber Mats with Small Diameter Spread," *Nanotechnology*, vol. 28, no. 42, p. 425302, Oct. 2017.

FireFly: An Insect-scale Aerial Robot Powered by Electroluminescent Soft Artificial Muscles

S. Kim, K. Chen
Sponsorship: RLE, MIT

Bioluminescence in natural fireflies is an effective and unique feature that enables communication and mating. Inspired by fireflies in nature, we develop a sub-gram (650 mg) aerial robot that emits light during flight (Figure 1). Simultaneous actuation and light emission are achieved by embedding electroluminescent (EL) particles in a dielectric elastomer actuator (DEA) that has highly transparent electrodes. During robot flight, a strong ($> 40 \text{ V}/\mu\text{m}$) and high frequency (400 Hz) electric field is generated within the DEA, exciting the EL particles to emit light. Compared to the original DEA, our new design and fabrication methods require small additional weight (2.4%) and actuation power (3.2%) without adding any robotic component. We further evaluate DEAs' mechanical and electrical behaviors with the addition of EL particles, and improve the EL-DEA designs to ensure the robot performance (maximum lift and lifetime) remains unchanged.

Light emission in sub-gram aerial robots enables motion tracking with miniaturized cameras that are receptive to visible light. We develop a fabrication process in which each ELDEA exhibits a different color or pattern (Figure 1). This design makes each ELDEA a unique active marker for visual tracking. We demonstrate controlled hovering flights using a sub-gram robot powered by four ELDEAs (Figure 2). The robot position and attitude are tracked through both a Vicon motion tracking system and a set of three smartphone cameras (Figure 2). Compared to the Vicon system, visual tracking shows a root-mean-square (rms) position and attitude error of 2.55 mm and 2.60 degree, respectively. This result shows the potential of using off-the-shelf microscale cameras for enabling controlled flights. In future studies, we envision light emission can be crucial for enabling communication in coordinated swarm flights of sub-gram aerial robots.

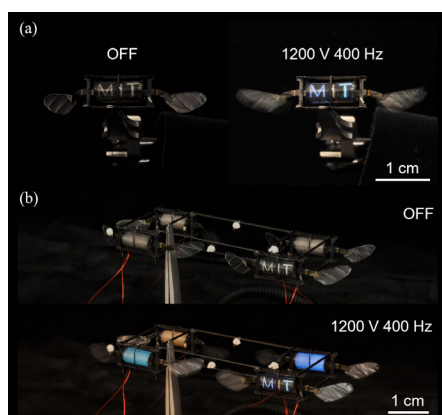

◀ Figure 1: A sub-gram aerial robot powered by ELDEAs. (a) One ELDEA is patterned with three letters, “MIT,” and each letter emits a different color when the ELDEA is driven at 1200 V and 400 Hz. (b) Four different colored or patterned ELDEAs are installed in a 650-mg flapping wing robot. The robot emits light when it operates at hovering flight conditions.

▼ Figure 2: Automated tracking and trajectory reconstruction based on the smartphone videos. (a) Automated tracking of the four ELDEAs in the top, side, and front view videos. (b) Camera pose calibration and reconstructed 3D trajectories of each ELDEA. (c) An inset graph of (b) that compares the vision-tracked trajectories with that from the Vicon motion tracking system.

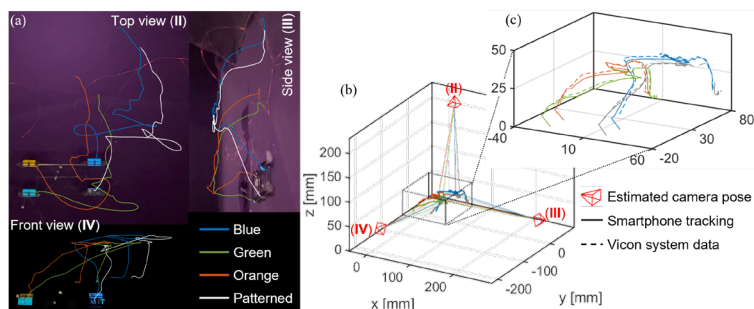

FURTHER READING

- Y. Chen, et al., "Collision Resilient Insect-scale Soft-actuated Aerial Robots with High Agility," *IEEE Transactions on Robotics*, to be published, 2021, DOI: 10.1109/TRO.2021.3053647.
- Y. Chen et al., "Controlled Flight of a Microrobot Powered by Soft Artificial Muscles," *Nature*, vol. 575, no. 7792, pp. 324-329, 2019, DOI: 10.1038/s41586-019-1737-7.
- R. Zhijian, et al. "A High-Lift Micro-Aerial-Robot Powered by Low-Voltage and Long-Endurance Dielectric Elastomer Actuators." *Advanced Materials*, p. 2106757, 2022.

Soft Material Design of Additively Manufactured Actuators to Control Stress Distribution

H. J. Lee, L. F. Velásquez-García
Sponsorship: Empiriko Corporation

Rigid materials are ubiquitous in engineering because their behavior is easy to predict and can support a great amount of weight. However, they are not suitable in unpredictable environments and can be dangerous when used in systems that involve human interaction. Soft and flexible materials, on the other hand, are compliant and can deform to match the shape of any object that comes into contact; this allows the structure to distribute stress and enable safer interaction with the environment. As a result, soft materials are now used in a wide range of applications including flexible electronics, soft robotics, and biological applications. While there are many methods to manufacture structures with soft materials, recent development in additive manufacturing allows fabricating complex designs with geometrical features unmatched by traditional manufacturing methods. Therefore, the structures can be designed to improve many properties for structural or thermal applications.

In this project we are designing and fabricating soft actuator structures to improve the fatigue properties under cyclic compression. Under compression, soft materials tend to fold themselves, which leads to a significant amount of stress concentration. While this might not be a problem for a small number of compressions, the fatigue life becomes an issue when the structure is applied to actual products that require a reasonably long lifespan. In addition to the material properties, structures fabricated through additive manufacturing have anisotropic behavior, where failure is most likely to occur between layers. Figure 1 shows the stress concentration of a flexible ring with a design that distributes the stress to a wider area, reducing the maximum stress within the structure. These designs can easily be fabricated with additive manufacturing, as shown in Figure 2. The sample shown is fabricated with Ninjaflex (a commercial thermoplastic polyurethane printable material) using an extrusion 3D printer.

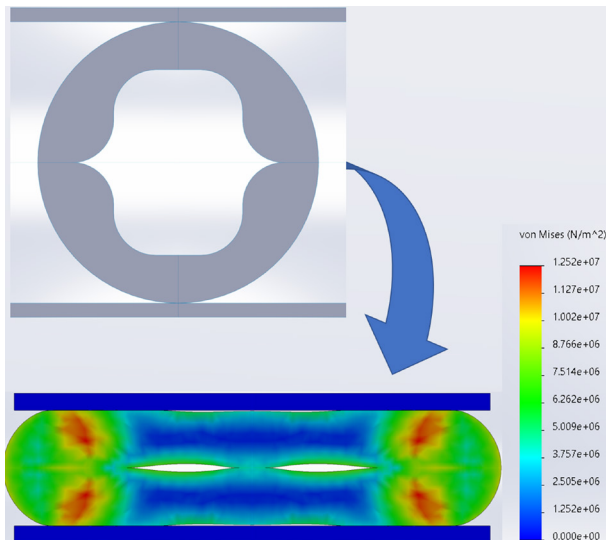

▲ Figure 1: Solidworks was used to simulate the compression of a hyperelastic material. The structure is designed to distribute stress concentration to improve the fatigue property.

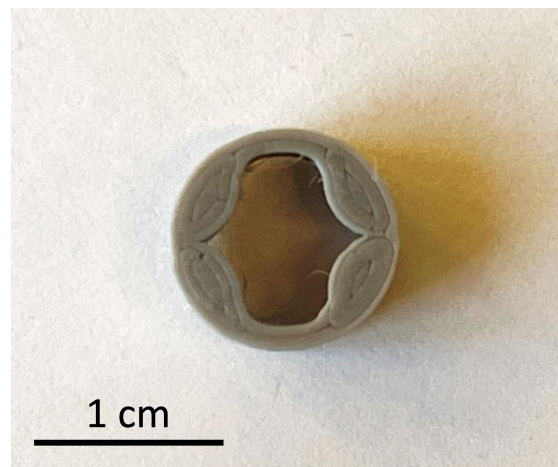

▲ Figure 2: Image shows the structure fabricated through additive manufacturing.

FURTHER READING

- A. P. Taylor, J. Izquierdo Reyes, and L. F. Velásquez-García, "Compact, Magnetically Actuated, Additively Manufactured Pumps for Liquids and Gases," *Journal of Physics D – Applied Physics*, vol. 53, no. 35, p. 355002, Aug. 2020.
- P. Taylor, C. Vélez Cuervo, D. Arnold, and L. F. Velásquez-García, "Fully 3D-printed, Monolithic Magnetic Actuators for Low-cost, Compact Systems," *Journal of Microelectromechanical Systems*, vol. 28, no. 3, pp. 481-493, Jun. 2019.
- A. P. Taylor and L. F. Velásquez-García, "Miniaturized Diaphragm Vacuum Pump by Multi-material Additive Manufacturing," *Journal of Microelectromechanical Systems*, vol. 26, no. 6, pp. 1316-1326, Dec. 2017.

Improving Reliability and Performance of Microhydraulic Electrowetting Actuators

J. Kedzierski, I. Liu, L. Racz, L. F. Velásquez-García
Sponsorship: MIT Lincoln Laboratory

Electrowetting is the phenomenon of altering the surface tension and wetting properties of liquids by applying electric fields. Applying an external voltage to a liquid droplet changes the droplet's shape and contact angle to solid surfaces, thus affecting the attraction and friction between droplets and solid surfaces. Electrowetting can reversibly transport and shape fluids; thus these effects have been used in multiple applications for manipulating small amounts of liquids, such as adjustable fluid optical lenses and droplet display arrays.

Microhydraulic actuators can be made by assembling a rotor and a stator separated by liquid droplets. Applying external electric fields to the droplets modifies the wetting and surface properties, thus actuating the droplets. Microhydraulic actuators offer several benefits over conventional motors. Microhydraulic actuators are lighter, flexible, and scalable to small dimensions. In contrast, conventional motors that rely on wire coils are often limited by coil

size and high resistance when scaled down. The small scale of microhydraulic actuators leads to high power density, enabling effective conversion of electrical to mechanical power in compact spaces.

This project is based on prior work at Lincoln Laboratory regarding rotational microhydraulic actuators. The rotor moves relative to the stator by applying external electric fields to the droplets, modifying the wetting and surface properties with electrowetting. The main goal is to improve reliability—currently, the main challenges include lowering friction, stabilizing

rotation, and extending operation time. The project will include experiments to determine the root causes of unreliable operations and incorporate corresponding design changes. The resulting microhydraulic actuators will combine reliable operations with high power density, small size, and precise motion. Thus, the project has vast potential in biomedical and robotics applications.

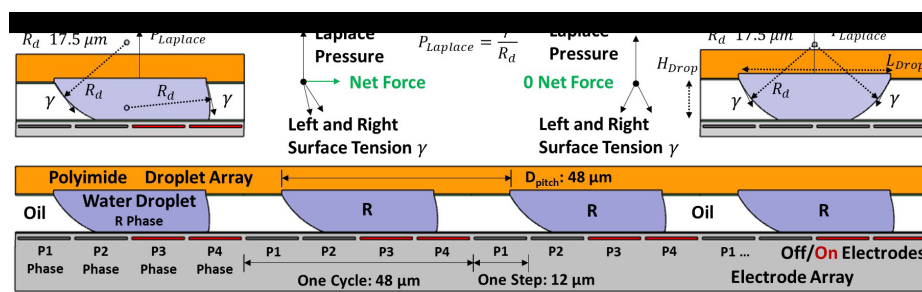

▲ Figure 1: Operating principle of microhydraulic actuators. Water droplets are shifted along by applying sequential electrical phases. From Kedzierski et al., *Science Robotics* 3, no. 22, eaat5643, 2018.

FURTHER READING

- J. Kedzierski and H. Chea, "Multilayer Microhydraulic Actuators with Speed and Force Configurations," *Microsystems & Nanoengineering* 7, no. 1, pp. 1–10, 2021.
- J. Kedzierski and E. Holihan, "Linear and Rotational Microhydraulic Actuators Driven by Electrowetting," *Science Robotics*, vol. 3, no. 22, p. eaat5643, 2018.

3D-Printed Reflectron for Compact Mass Spectrometry

N. Lubinsky, L. F. Velásquez-García
Sponsorship: Empiriko Corporation

Accurate measurement of blood plasma constituents in the medical clinical setting is incredibly important for drug assays and monitoring of biomarkers. However, the traditional gold standard is a triple quadrupole, an investment requiring a large amount of power, space, and a \$10 million budget. Other applications for low false-positive, compact mass spectrometry also face the same economical burdens. Our research group aims to mitigate these with the additive manufacture methods available to 3D printing mass spectrometers for high precision and miniaturization.

We are currently exploring a two-piece reflectron mass spectrometer—a device that measures the time-of-flight (TOF) of ions as they are reflected by the internal electromagnetic fields. The design geometry of a hyperbola (Figure 1) surrounded by a cone creates a potential distribution that is quadratic with distance. Thus, the ions exhibit a repelling force that is independent of the initial energy of the ion; therefore,

we can observe a TOF solely dependent on the specific mass-per-charge of the ions.

Methods of operation employed by this reflectron involve the utilization of an entrance gate electrode, with an aperture for ions. Once potential drops to 0 V on the gate, ions flow into the reflectron, ultimately reflecting towards the entrance, to a nearby anode. Ions colliding will draw current; however, the current intensity will vary in time depending on the TOF of the ions. The delay of the gate switching off to the time we register current intensity is completely dependent on the specific charge of the ion, and mass spectrometry can be performed. In our approach, the electrodes are 3D-printed in glass-ceramic via digital light processing (DLP). Post-print, we selectively plate them, forming conductive surfaces. Current research efforts focus on optimizing the hardware and characterizing such hardware in vacuum.

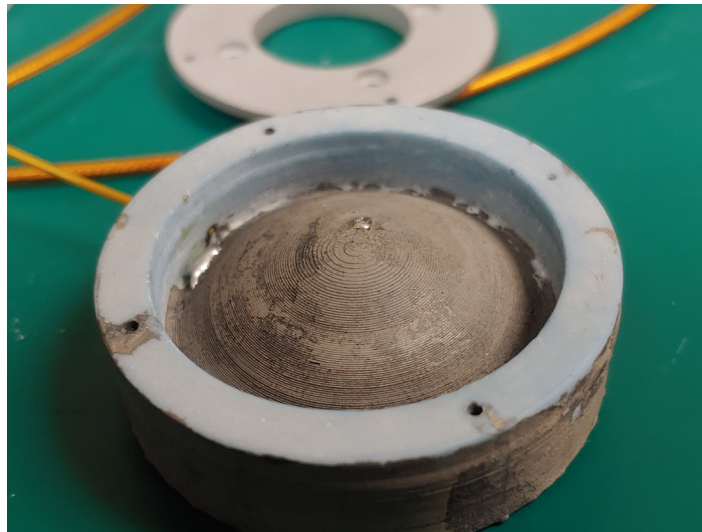

▲ Figure 1: Hyperbolic electrode 3D printed in glass-ceramic via DLP and coated in nickel.

FURTHER READING

- Z. Sun, G. Vladimirov, E. Nikolaev, and L. F. Velásquez-García, "Exploration of Metal 3-D Printing Technologies for the Microfabrication of Freeform, Finely Featured, Mesoscaled Structures," *J. Microelectromech. Sys.*, vol. 27, no. 6, pp. 1171-1185, Dec. 2018
- L. F. Velásquez-García, K. Cheung, and A. I. Akinwande, "An Application of 3D MEMS Packaging: Out-Of-Plane Quadrupole Mass Filters," *J. Microelectromech. Syst.*, vol. 16, no. 6, pp. 1430-1438, Dec. 2008.
- E. Nikolaev, M. Sudakov, G. Vladimirov, L. F. Velásquez-García, P. Borisovets, and A. Fursova, "Multi-Electrode Harmonized Kingdon Traps," *Journal of the American Society for Mass Spectrometry*, vol. 29, no. 11, pp. 2173-- 2181, Nov. 2018.

MEMS Digitalized Igniter or Primer for Solid Propellant Grains and Two-spool Micro Gas Turbine Engine Concept

J. Protz

Sponsorship: Protz Lab Group, microEngine, LLC

Micro-fabricated chemical rocket engines and jet engines have been researched at MIT for over two decades; they are a compelling propulsion option for small air- and space-craft. The investigator's most recent work focuses on microchips as replacements for igniters or primers in model rocket motors and bullets, allowing these to serve as an inexpensive final stage for a miniaturized launch vehicle. As envisioned, a sq. mm-sized micro-electromechanical system (MEMS) chip would combine a complementary metal-oxide-semiconductor (CMOS) guidance computer, MEMS sensors, and a MEMS solid- or liquid- propellant micro rocket motor. The chip would replace the igniter of an otherwise-conventional solid-propellant model rocket motor or the primer of an otherwise-unmodified bullet. By monitoring its evolving state on a waving launch rail and actively timing the firing of the plume of the MEMS rocket into the grain of the solid motor or bullet, the guidance computer would regulate the initial con-

ditions of a ballistic object's trajectory. If the projectile was a satellite, this would regulate its orbital insertion. The advantage of the concept is that it economizes on chip size and, thus, system cost; fine control of initial condition can be an inexpensive alternative to mid-flight control. The effort is in an early stage and focuses on identifying mature technologies that can be joined as a system; if successful, it could enable hobby rocket-sized launch vehicles that utilize concepts already proven by the Japanese at a larger scale. Other recent work by the investigator has focused on mocking up in wood a MEMS-compatible two-spool jet engine configuration that combines a combustor, high-speed turbocharger, and low-speed cold turbine with an integrated electrical generator and mocking up in brass a miniature rocket engine configuration that integrates a steam injector, boiler, decompression chamber, fuel injector, thrust chamber, and battery- powered electric fuel pump.

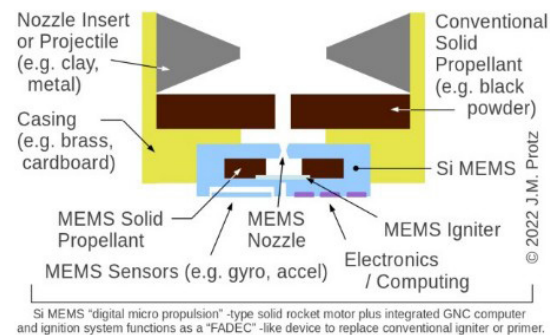
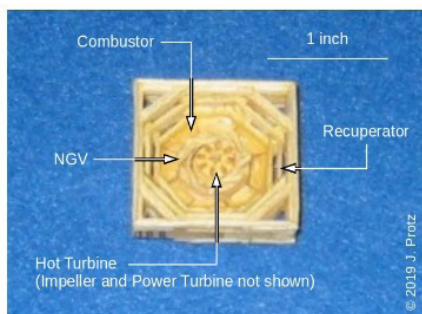

▲ Figure 1: (left) mock-up in wood of a MEMS-compatible micro gas turbine engine with cold turbine; (right) depiction of a MEMS "FADEC" (digitalized igniter or primer) for firing a solid propellant grain.

FURTHER READING

- J. M. Protz, "MEMS Compatible Solid and Liquid Micro Rocket Engines and Micro Gas Turbine Engine," *Proc. MIT MTL Annual Research Conf. (MARC 2022)*, S2.14, 25-26 Jan. 2022.
- J. M. Protz, "Progress Towards an Injector-Pumped Micro Rocket Engine and Vehicle (and Cost of Launch)," *Gas Turbine Laboratory Seminar*, MIT, Cambridge, MA, 7 May, 2019.
- J. M. Protz, "Hybrid and Partially Pressure-Fed Injector-Pumped Micro Rockets," (JANNAF 2019-004BT), presented at the *Joint Army-Navy-NASA-Air Force Joint Meeting of the 13th Modeling and Simulation / 11th Liquid Propulsion / 10th Spacecraft Propulsion Subcommittees and Meeting of the Programmatic and Industrial Base (JANNAF)*, Tampa, FL, 2019.

Advanced Electromembrane Process for Portable Desalination Unit

J. Yoon, J. Han

Sponsorship: Abdul Latif Jameel Water and Food Systems Lab (J-WAFS), U.S. Army Combat Capabilities Development Command-Soldier Center

Climate change and human activity are accelerating the water crisis. Seawater desalination plants are a good solution for people in urban areas but are unsuitable for small groups in rural areas and instance demands due to natural disasters. Miniaturized desalination units, known as portable desalination units, have been developed to provide a secure source of drinking water to these groups. Only reverse osmosis-based portable desalination units have been on the market, but they are heavy (> 20 kg) and have power-intensive operation (100–400 W) due to high production rate (> 20 L/h). A need remains for a lightweight and energy-efficient portable desalination unit.

The ion concentration polarization (ICP) process using only cation exchange membrane has been developed to improve energy efficiency and overcome the limitation of electrodialysis (ED). The ICP process has been proposed because a higher diffusivity of anion leads to a thicker diffusion boundary layer next

to the cation exchange membrane, which is already known theoretically and experimentally in ED. The ICP process improves ~20 % over current utilization compared to ED when treating seawater. At the same time, dilute and concentrated streams appear in the same spacer, facilitating the removal of suspended solids that ED does not enable.

We present a fully packaged portable desalination unit using an advanced electromembrane process, where the ICP process and ED are serially stacked, forming a multi-stage process. The components, multi-stage module, pumps, customized controller, and battery are assembled in a hard case 42 x 33.5 x 19 cm³ with a total weight of 9.4 kg. It allows conversion of both brackish water (2.5 ~ 10 g/L) and seawater (30 ~ 45 g/L) into drinking water with the corresponding specific energy consumptions, 0.4 ~ 4 and 15.6 ~ 26.6 Wh/L, respectively. The unit successfully deployed on the beach to make seawater into drinking water.

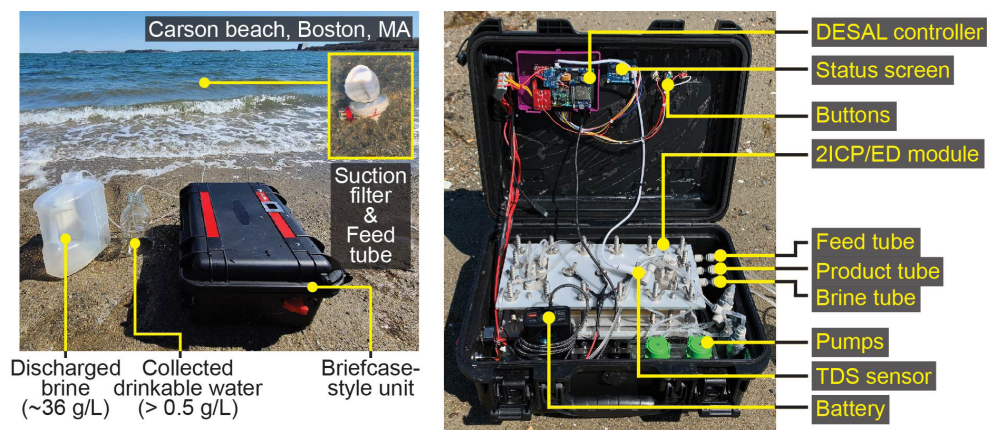

▲ Figure 1: Finished, fully integrated portable desalination unit. The photograph of the portable desalination unit deployed on Carson beach and the configuration of the internal parts.

FURTHER READING

- J. Yoon, H. J. Kwon, S. Kang, E. Brack, and J. Han, "Portable Seawater Desalination System for Generating Drinkable Water in Remote Locations," *Environmental Science & Technology*, vol. 56, no. 10, pp. 6733-6743, 2022. <https://doi.org/10.1021/acs.est.1c08466>.